

**ThinkPower**



# ThinkPower User Manual

- Installation
- Operation
- Maintenance



## PV Grid-Connected Inverter

- S1000TL ○ S2200TL ○ S3000TL ○ S3600TL
- S4400TL ○ S5000TL ○ S6000TL



## Introduction

### For readers

This manual is applicable for technicians of inverter installation, operation and maintenance. The readers shall be familiar with electrical knowledge.

### About this manual

Please read this manual carefully before using products. This manual shall be kept in a place which is convenient to use. Operator using this manual must be a qualified electrical engineer certified by the local electrical authority.

### Copyright

This manual updates are subject to products upgrades, and there might be some unconformity between the manual description and the products, and users can acquire the latest version from us. The manual updates are not to be further notified.

### Applicable Models

This manual provides the installation, operation and maintenance of PV grid-connected inverters S1000TL-S6000TL. The following models of inverter are related:

- S1000TL
- S2200TL
- S3000TL
- S3600TL
- S4400TL
- S5000TL
- S6000TL

### Revision

Revised version No.	Date	Description
XQ-UMT1.1.0CN	2024.01.04	Rev.1

## Important safety instruction

### Symbols in this manual

To ensure the personal and property safety in using the photovoltaic inverter and the high efficiency of the product, related safe operation notices are provided in the manual, and corresponding symbols are used for emphasizing the importance. These important notices must be fully understood and followed. Symbols used in this manual are listed below to help you carefully read and use this manual.



It means a highly potential danger which may cause a serious personal injury or death directly if this warning is neglected.



It means a moderately potential danger which may cause a serious personal injury or death directly if this warning is neglected.

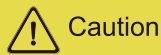

It means a lightly potential danger which may cause a light or moderate personal injury or serious property loss if this warning is neglected.



It means a potential risk which may cause device malfunction or property loss if this warning is neglected.



Tip

It means an additional notice emphasizing or complementing the content, or providing a tip for optimizing the product operation, and further helps you solve some problems or save some time.



It means a helpful reference or notice.

## Symbols on the inverter

The inverter is attached with some labels related to operation safety. Please don't install the device until carefully read through and fully understand these labels.



It means there is still residual voltage in the inverter! The capacitor is still electrified after the AC/DC side of the inverter is cut off, so the inverter cannot be maintained within 10min till the capacitor is completely discharged.



Danger of high voltage and electric shock!



Danger of high temperature and burn injury!



Earth line!



The wasted product must be sent to the authorized collecting center.



Please carefully read through and fully understand the instruction manual before using the product.



Acceptable in the test of insulation and voltage resistance.



Acceptable in the function test.



Acceptable in the quality inspection.

---

<b>Contents</b>	
<b>1 Safety instruction.....</b>	<b>1</b>
1.1 Before installation.....	1
1.2 During installation.....	2
1.3 Operation.....	2
1.4 Repair.....	2
1.5 EMC.....	3
<b>2 Product description.....</b>	<b>4</b>
2.1 Product applicability.....	4
2.2 Circuit structure.....	4
2.3 Product introduction.....	5
2.3.1 Electrical connecting part.....	5
2.3.2 Dimensions and weight .....	6
2.3.3 LCD Displaying panel.....	7
<b>3 Installation.....</b>	<b>8</b>
3.1 Safety instruction.....	8
3.2 Installation procedures.....	8
3.3 Preparation before installation.....	9
3.3.1 Unpacking and checking.....	9
3.3.2 Tools preparation.....	10
3.4 Section of installation position.....	10
3.5 Inverter Installation.....	12
3.5.1 Installation Guide .....	12
3.6 Electrical connection.....	13
3.6.1 Electric and electrical system structure.....	14
3.6.2 Wiring terminals and cable specification.....	14
3.6.3 Steps for electrical connection.....	16
3.6.3.1 Steps for DC connection.....	17
3.6.3.2 Steps for AC connection.....	19
3.6.3.3 DC /AC teminal Connection.....	21
3.6.4 Earthing requirement.....	22
<b>4 Trial operation.....</b>	<b>23</b>
4.1 Check before operation.....	23
4.1.1 Check for reliabilty of mechanical installation.....	23
4.1.2 Check for connecting cables.....	23
4.1.3 Electrical check.....	23
4.2 Electrify the inverter.....	23
<b>5 Human-machine interaction.....</b>	<b>24</b>
5.1 LCD interface.....	25
5.2 Internal data storage.....	25
5.3 Introduction of the function of monitoring software... ..	25
5.3.1 Main interface.....	25
5.4 Inverter working mode.....	26
5.4.1 Power generating mode .....	26
5.4.2 Protection mode .....	26

5.4.3 Fault mode .....27

5.5 LCD panel mode..... 28

5.6 LED blink table ..... 28

**6 Troubleshooting and maintenance.....29**

6.1 Troubleshooting.....29

6.2 Daily maintenance .....32

**7 Uninstallation..... 32**

7.1 Uninstallation steps..... 32

7.2 Packing..... 33

7.3 Storing.....33

7.4 Solution at the termination of service period.....33

**8 Technical parameters.....34**

8.1 S series parameter .....34

8.2 S series parameter ..... 36

**9 Quality assurance.....38**

9.1 Warranty Policy.....38

9.2 Exception clause.....38

9.3 Warranty card.....39

## 1 Safety instruction

 **Tip** Please contact us if you have any problems .

S1000TL- S6000TL Series inverters are designed, manufactured and tested as per international safety standards. However as an electrical and electric product, it must be installed, operated and maintained strictly according to related safety notices.

If you have any problems, please contact the nearest service center or authorized dealer. Please do NOT install or repair the product by anyone who is not qualified by local authority.

We are not responsible for any damage or loss caused by misuse or misunderstanding of the information in this manual.



**Warning**

Misuse or misoperation may harm:

- The personal safety of the operator or a third person.
- The property safety of the inverter or any other property.

### 1.1 Before installation



**Warning**

The inverter cannot be connected to the grid unless approved by the electrical authority, and it must be installed according to the local standard and related standard for an electrical enterprise.



**Notice**

Please check if there is any damage on the package or the product before installing. The inverter is electrical radioactivated, Please choose a suitable place for installing.

## 1.2 During installation



Keep the PV array covered and the DC circuit breaker OFF. High voltage will be generated by PV array exposed under sunshine. All the cables must be connected firmly.



The inverter must be installed by a qualified electrical engineer certified by the local authority, and the installation manual must be read through before installation. It must be installed according to the local standard and related standard for an electrical enterprise.

## 1.3 Operation



- High voltage is a hazard, make sure keep the device away from children.
- Any touch with the device or terminal may cause electric shock or fire. Please follow all the safety instructions.
- A damaged device or system fault can cause electric shock. Make sure that you have checked the package and the device before installation to avoid unnecessary damage or loss.

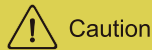

Be aware of the hot surface while the device is running.

## 1.4 Repair



Completely switch off the connection between the inverter and the grid, DC side connection. Wait for 10 minutes until the internal elements are fully discharged.



Do NOT restart the inverter before all the hazards have been removed. Please contact your local dealer and always have licensed trader do the repairing.

## 1.5 EMC

EMC(Electro Magnetic Compatibility) means the resistance of a device or system against generating any Electro Magnetic interference to the environment without influencing the normal operation in the Electro Magnetic environment.

- Immunity to the own noise; Immunity to the internal electrical noise.
- Immunity to the external noise; Immunity to the external Electro Magnetic noise.
- Noise radiation level: influence of Electro Magnetic radiation to the environment.



- The Electro Magnetic radiation of the inverter is harmful for health.
- Please never stay within 20cm from a running inverter for long.

## 2 Product description

### 2.1 Product applicability

By S1000TL-S6000TL series inverter, the DC voltage generated in the PV array can be transformed into AC voltage and supplied to the grid. The PV power generating system consists of PV arrays, inverters, meters and a public grid.

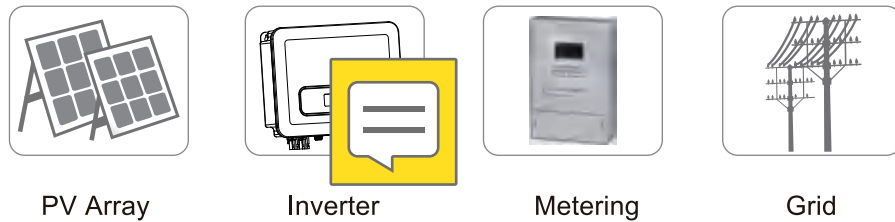

Fig. 2-1

The research, development and manufacture of 1000TL-S6000TL series are integrated with the most updated techniques and public confirmed safety regulations. However, improper operation or misuse may still cause injury or loss. Instruction and information provided in this manual must be followed all the time.

### 2.2 Circuit structure

Fig.2-2 shows the internal functional diagram of 1000TL-S6000TL series inverter. After the PV array input enters the voltage boosting circuit via the filter circuit, the input DC voltage is boosted and stabilized to BUS value for the full-bridge inverter circuit, and in this process, the MPP tracker in the inverter will ensure the DC energy generated in the photovoltaic array can be used by the inverter circuit at maximum and the DC current will be conveyed into the grid.

The joint of the input and output EMC can effectively reduce the interference between the inverter and outside. CPU1 and CPU2 control the inverter operation and monitor the operation state, and in any abnormal working condition, it will protect the inverter and external device and personal safety according to the reserve program thus extremely improve the stability and reliability of the system.

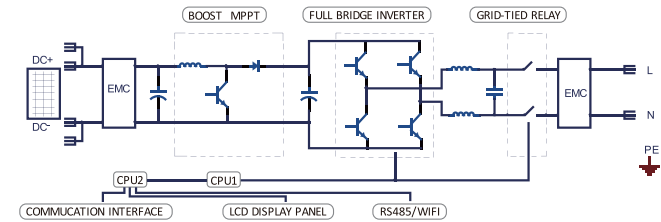

Fig.2-2

### 2.3 Product introduction

#### 2.3.1 Electrical connecting part

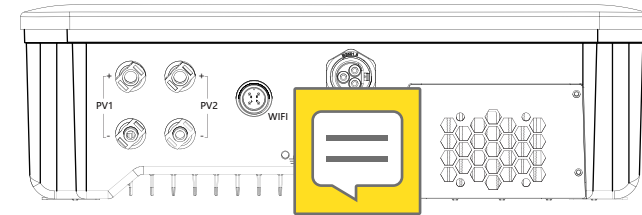



Fig.2-3

Tab. 2-1: Description for the electrical connecting part of the inverter

Name	Description
DC+	The positive part of terminals connecting the PV array
DC-	The negative part of terminals connecting the PV array
RS485 (1/2)	Standard communication mode
AC Output	Connected to the grid

 Instruction

A DC switch is recommended in consideration of safety, in some countries, it is imperative for the connection of PV array and inverter; users can select a proper type for T series inverters accordingly.”

 Notice

Waterproof I/O terminal are located at the bottom of the inverter. Be cautious when handling and installing to prevent any damage.

2.3.2 Dimensions and weight

S1000TL-S4400TL

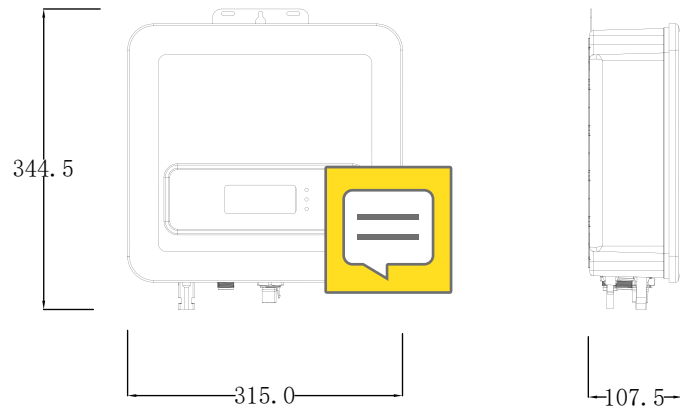

S5000TL-S6000TL

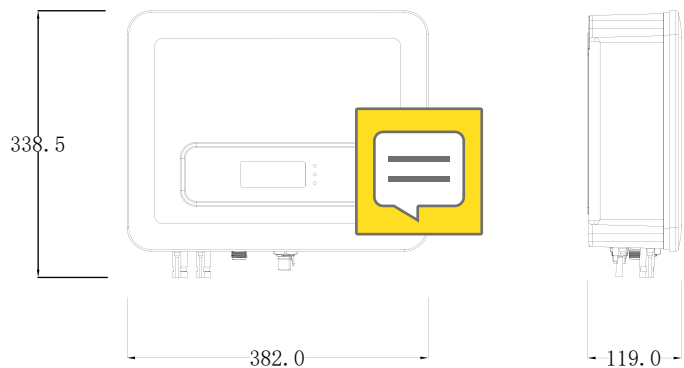

Fig.2-4

Tab.2-2: Inverter weight

Model	S1000TL	Weight	5.2 Kg
Model	S2200TL	Weight	5.2Kg
Model	S3000TL	Weight	5.2Kg
Model	S3600TL	Weight	5.2 Kg
Model	S4400TL	Weight	5.2 Kg
Model	S5000TL	Weight	9 Kg
Model	S6000TL	Weight	9 Kg

2.3.3 LCD Displaying panel

The inverter is totally computerized and all the status are displayed on the LCD screen, the screen is also sound-sensitive, it will turn into sleep mode in 2 minutes with no operation. You can wake up the screen just by slightly clicking the plastic shell around the LCD displaying panel.

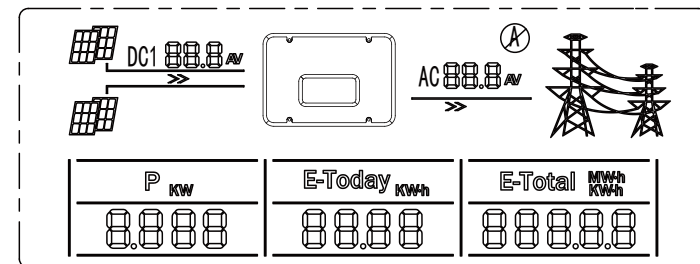

Fig. 2-5

### 3 Installation

#### 3.1 Safety instruction



The DC voltage at the PV array and the AC voltage at the grid side are both higher than the safe voltage. It is forbidden to touch any electrified terminal directly. Make sure the DC side is not electrified before installation and maintenance.

The inverter must be installed, operated or maintained as per the following standard and instruction, and it can not be connected to the grid for power generating unless approved by the local power supply authority, and all operation must be performed by a qualified electrical engineer.

- All electrical installation must be performed according to the local standard of electrical installation.
- No internal part except the wiring terminal can be touched during installation.
- A running inverter has a very high voltage, so no internal operation can be carried out within 10 min at least after the AC and DC power supply of the inverter is turned off. Please make sure there is no dangerous residual current by measuring the DC voltage with a multimeter to ensure that the capacitors are fully discharged.
- Caution the hot surface of the inverter. For example, the heat radiating from the power semiconductor will remain at a high temperature after the inverter is shut down.
- The inverter is delivered without any user's self-maintenance components, so please contact the local authorized installation and maintenance technician if maintenance needed

#### 3.2 Installation procedures

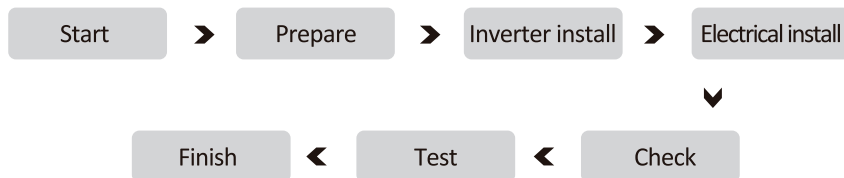

Fig.3-1

See the following instruction for details.

### 3.3 Preparation before installation

#### 3.3.1 Unpacking and checking

The product is carefully tested and checked before transportation, however it is still possible to be damaged during transportation, please check the device again before installation. If any damage, please contact the transportation agency or directly contact our company. Please take picture of the damage; best and efficient help will be offered.

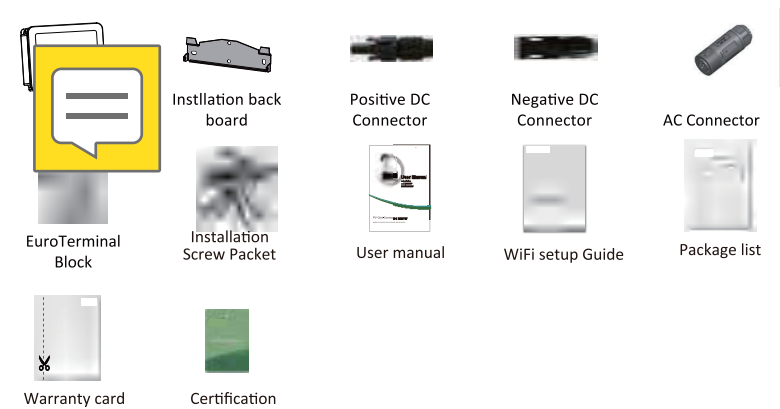

Fig. 3-2

Tab. 3-1: Package list

No.	Description	Qty	Remark
1	Inverter	1	
2	Installation Back Board	1	
3	Positive DC Connector Packet	1	The number of S3600TL-S6000TL is two
4	Negative DC Connector Packet	1	The number of S3600TL-S6000TL is two
5	AC Connector Packet	1	For the connection of grid
6	Euro Terminal Block Packet	1	For the RS485 communication
7	Installation Screw Packet	1	For the back board installation
8	User Manual	1	Please read through carefully
9	WiFi setup Guide	1	Instructions on connecting your inverter to your WiFi
10	Package List	1	Check the delivery according to the package list
11	Warranty Card	1	Please well keep for filling and returning us if there become any fault in the inverter
12	Certification	1	

### 3.3.2 Preparation for tools

The following tools will be used for installing the inverter:



φ 10 percussion drill Press pinchers Screw driver and wrench Multimeter Hammer

Fig.3-3

### 3.4 Selection for a installation position



Some parts (e.g.: heat radiator) of the inverter runs with a high temperature, so it is not suitable for installing near inflammables or explosives.



- When selecting an installation position, please avoid the influence of noise and electromagnetic radiation to the environment.
- The inverter can not be installed near any place of high external electromagnetic radiation (e.g.: a TV tower, communication signal tower or HV cables).



The inverter performance will be degraded if the environmental temperature is 45 °C above. Make sure the inverter is installed in a well ventilated place so that the power generation can be maximized.

Detailed requirement for installation position:

- ※ The installation of the inverter should be protected under shelter from direct sunshine or any bad weather conditions as shown below:

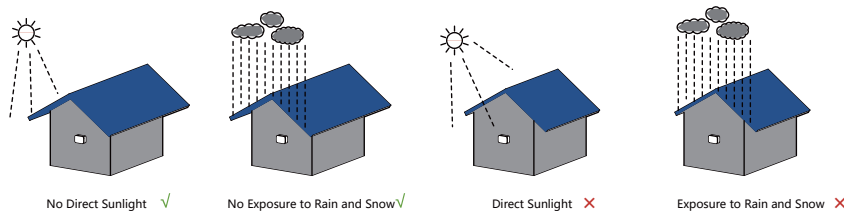

- ※ The inverter shall be installed in a cool & dry place with temperature from -25 °C- +60 °C; The environmental relative humidity is not higher than 95% and without any condensation.
- ※ The inverter LCD shall be leveled with eyes and with enough space in the front for inspection.
- ※ To avoid burning or electric shock, the inverter shall be installed beyond reach of children. The temperature of some parts (e.g. : the heat radiator) is high when the inverter is running.
- ※ Make sure the installation position does not shake.
- ※ The inverter shall be installed in a well ventilated place to ensure the normal heat radiation.
- ※ The installation place shall be firm enough to support the inverter weight.
- ※ The inverter shall be installed on a vertical wall, or within 15° at most if backwards to the wall.
- ※ Connecting terminal is located at the bottom.

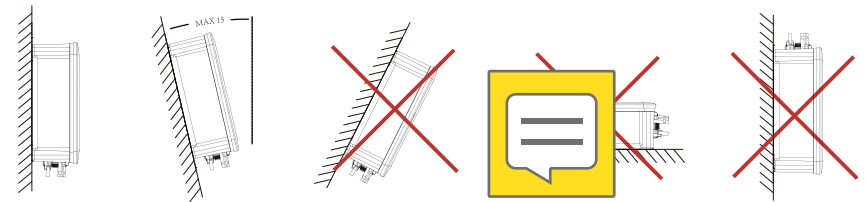

Fig.3-4

Tab.3-2: Effective spacing dimensions

Position	Min. size (cm)
Front	40cm
Lateral	40cm
Top	40cm
Bottom	50cm

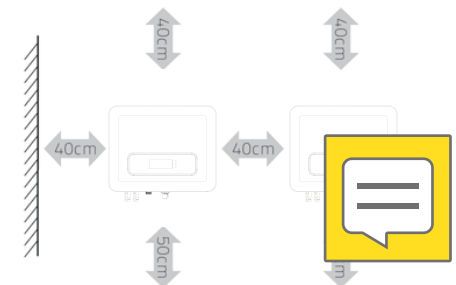

Fig. 3-5

### 3.5 Inverter installation



Please check that the open circuit voltage, short circuit current and maximum power at STC of the PV array are within the capacity of the solar inverter.  
The full load MPPT voltage range is within the 250V-480V.

#### 3.5.1 Installation Guide (Take T series as an example)

1) Take out the Inverter and fix it to the wall; then peel the three green logos on the back board and attach them to the wall through the hole. Thus the installation holes are marked.

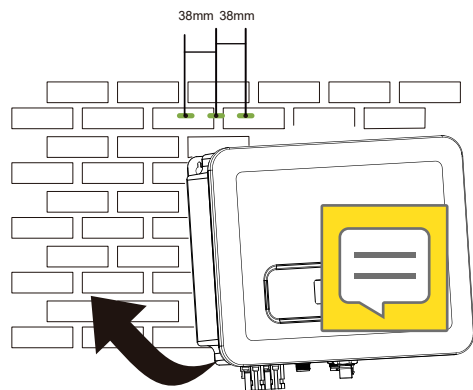

Fig. 3-6

- 2) Drill holes in the marked position as per the size of expansion screws.
- 3) Insert the expansion tubes into the hole, knock the tubes into the hole and make them level with the wall surface.

4) Fix the Inverter to the wall using the tapping screws tightly.

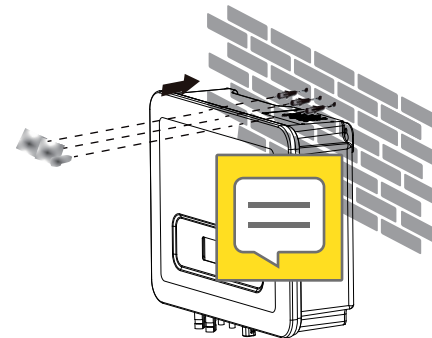

Fig. 3-7

### 3.6 Electrical connection

After the inverter is correctly installed on the wall or support, the next step is the electrical connection for the inverter. Electrical connection must be performed according to related safety standards.



A misoperation electrical connection may cause personal injury or death or damage the inverter irreversibly. Wiring operation must be performed by a qualified electrical engineer.



All electrical installation must be complying with local and national electrical standards.



The inverter cannot be connected to the grid unless approved by the local electrical authority and all electrical connections are completed by a qualified electrical engineer.



Please use cables of specification recommended by us, or the system safety may be deraded.

The electrical connection for an inverter covers electrical cable connection and communication cable connection.

### 3.6.1 Electric and electrical system structure

The electric and electrical connection for the whole solar energy power generation system is shown as below:

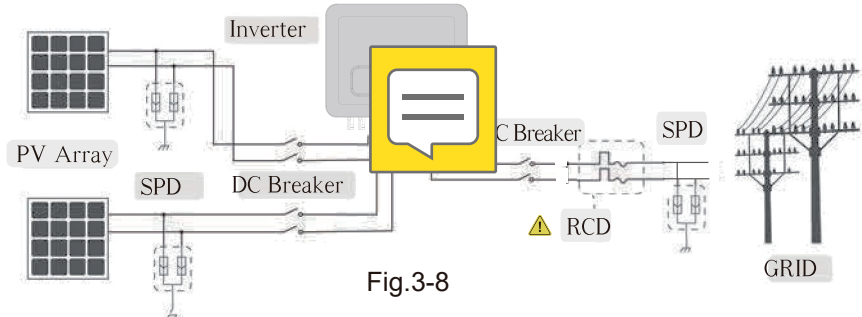

Fig.3-8

The PV array is connected to the inverter via a DC breaker, the inverter is connected to the grid via an AC breaker, and surge protection device (SPD) are configured on the AC and DC sides respectively.

If the inverter is equipped with the “AC Breaker including the RCD”, the parameter of the RCD refers to the following:

Tab.3-3: suggested RCD parameter

Number of inverter(s)/parallel	Suggested RCD parameter(mA)
1	≥50×1
2	≥50×
3	50×3
.....	.....
n	≥50×n

No load can be directly connected to the output side of the inverter.

### 3.6.2 Wiring terminals and cable specification

#### 1) DC wiring terminals

The DC side terminals are shown in the following figure :

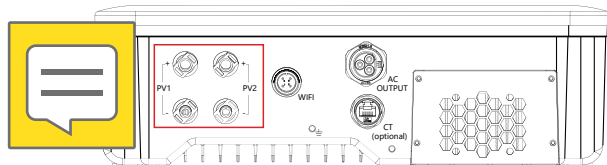

Fig.3-10

The wiring terminals as following:



Fig.3-11



Fig.3-12



Fig.3-13



Fig.3-14

#### 2) AC terminals



Fig.3-15



Fig.3-16

#### 3) Communication terminals

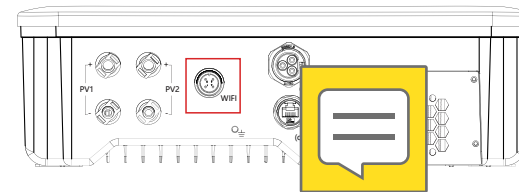

Fig.3-17

4) Cables of the following specification will be equipped by the user.

Tab.3-4: Recommended cable specification

Name	Min. sectional area (mm <sup>2</sup> )	Max. sectional area (mm <sup>2</sup> )	Recommended sectional area (mm <sup>2</sup> )
DC cable(+)	2	4	4
DC cable(-)	2	4	4
AC cable(L)	4	6	4
AC cable(N)	4	6	4
AC cable(GND)	4	6	4
Communication cable (RS485)	0.5	1.5	1

3.6.3 Steps for electrical connection



**Danger**

Please cover the PV array by lightproof material or switch off the DC circuit breaker before electrical connection. A dangerous voltage will be generated by the PV array exposed in the shine.



**Danger**

If the inverter has been electrified and tested before connection, wiring can not be performed unless the AC and DC power supplies are cut off for 10min and a multimeter shows that the DC side is totally discharged.



**Caution**

When designing the PV array, make sure the maximum open circuit voltage is not higher than 550V at each series of PV group. Otherwise the inverter will be damaged irreversibly



**Tip**

Different colors of cables shall be used for differentiating in assembling. For example: the positive pole is connected by a red cable and the negative by a blue cable.



**Tip**

In order to balance each PV series, Cable shall be with the same sectional area.



**Tip**

DC cable between the inverter and the assembly shall be the special PV cable. The voltage drop from the terminal box to the inverter is about 1-2%. It is recommended the inverter is installed on the assembly support for generation to reduce the cable cost and the DC loss.



**Tip**

High performance and high quality PV array shall be used. The open circuit voltage in the serial array must be lower than the maximum DC input voltage in the PV grid-tied inverter, and the working voltage of the serial array must comply with the MPPT voltage of the inverter.



**Notice**

- Protect the LCD panel during wiring;
- Protect the LCD panel and other elements from scratch or damage by cables or tools.

3.6.3.1 Steps for DC connection

Steps for DC cable wiring

1)Using the stripping tool to cut the PV cable, and makes the cooper wire reveal as 0.7cm.



Fig.3-18



Fig.3-19

2) Plug the cable into female terminal.



Fig.3-20

3) Process crimping.



Fig.3-21

4) Crimp closely between the terminal and PV cable.



Fig.3-22

5) The terminal is crimped well with PV cable wire.



Fig.3-23

6) Put terminal into connector.



Fig.3-24

7) The DC wiring finished.



Fig.3-25

### 3.6.3.2 Steps for AC connection

Installation Procedure

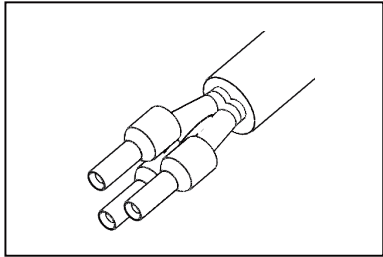

Crimp the terminals with crimping pliers

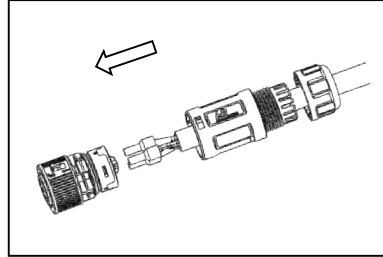

Set the parts on the cable, Insert the terminal holes in sequence

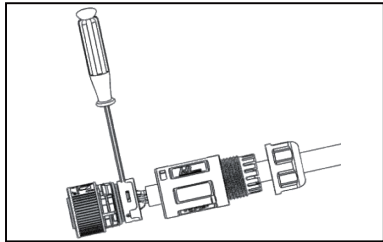

Crimp the wire with an inner hexagon screwdriver and screw the torque 12±0.1N·m

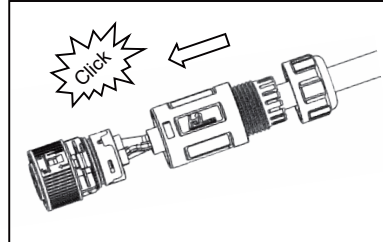

Insert the main body into the rubber core and hear the "click" sound

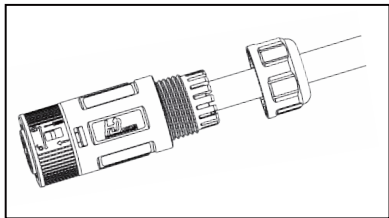

Tighten the nut with an open-ended wrench (torque 2.5±0.5N·m)

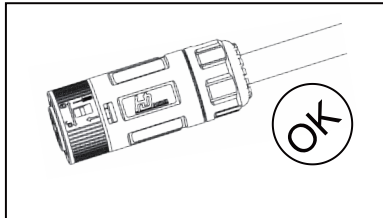

Complete the installation

Male and female butt (plate end)

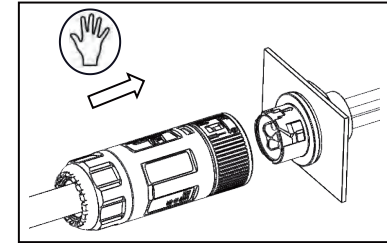

The installation arrow indicates insertion the female connector

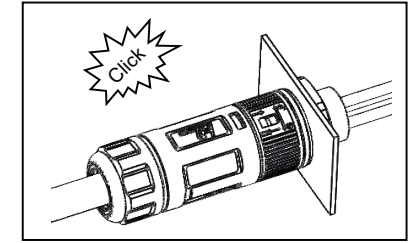

Complete the installation

5) The AC connection finished.

3.6.3.3 DC/AC terminal connection:

- 1) Make sure that the DC/AC breaker is switched off.
- 2) Insert the DC+/- wiring terminal into corresponding DC+/- terminal.

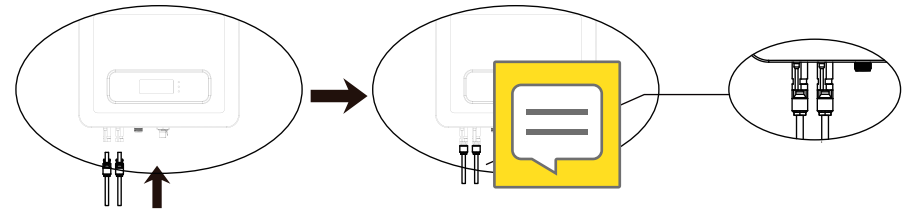

Fig.3-30

- 3) Insert the AC wiring terminal into the AC terminal.

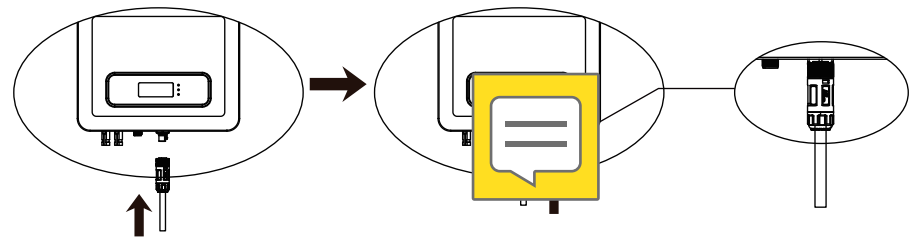
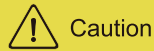

Fig.3-31

- 4) Switch on the AC breaker.
- 5) Switch on the DC breaker.

### 3.6.4 Earthing requirement



Caution

The inverter is a device with no transformer, neither the positive nor the negative pole of the PV assembly DC side can be earthed, or the inverter will not work normally, or even be damaged irreversibly.

In series PV power generating system, all device shells, assembly supports and the GND terminal of the inverter must be safety and reliably earthed.

## 4 Trial operation

### 4.1 Check before operation



Warning

Necessary safety check must be performed before the inverter is electrified for trial operation!

#### 4.1.1 Check for reliability of mechanical installation

Check if the inverter is firmly installed and if all bolts are reliably tightened. For an inverter installed on a metal supporter, make sure each bolt is tightened and support has enough load bearing capacity.

#### 4.1.2 Check for connecting cables

Check if all cables in the system are firmly connected without any missed or wrong connection, and especially check if all positive and negative poles are correct. If a DC switch is equipped on the inverter, the DC switch shall be turn to the "OFF" state.

#### 4.1.3 Electrical check

Make sure the DC input voltage of the inverter is lower than 550V (with the temperature decrease of the PV array, the open circuit voltage will be increased, so a residual voltage at the low temperature must be put into consideration).

Make sure the grid parameters are complying with the inverters parameters.

### 4.2 Electrify the inverter

The inverter can be started up as per the following steps after all testing and checking steps are performed.

Switch on the AC breaker, and then the DC breaker, if an inverter is with a DC switch, turn it to the "ON" state.

See Part 5 of this manual for "Human-machine interaction" after the inverter is started up. If enough power energy can be generated in the solar array, the inverter will be started up automatically, and LCD will display the normal status which means the inverter is successfully started up. If the inverter is not normally started up, please refer to Part 6 "Troubleshooting and maintenance".

## 5 Human-machine interaction

### 5.1 LCD interface

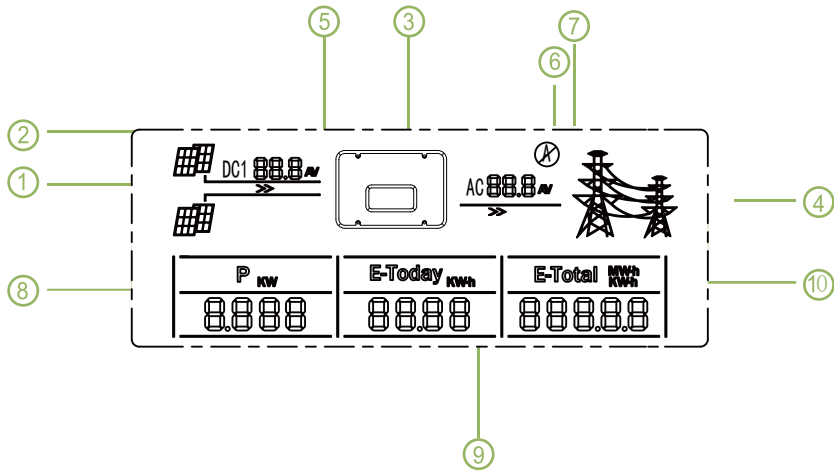

Fig.5-1

Tab. 5-1: Introduction to symbols on the LCD panel

SN	Symbol	Description
1	>>	It means the energy flow direction of the photovoltaic system
2		It means the PV panel
3		It means the photovoltaic inverter
4		It means the grid.
5		It alternately displays the input voltage/current of the DC side.
6		It alternately displays the voltage/current of the AC side.
7		Anti Reverse Limiter Setting
8	P kW	It indicates the current power, unit: KW.
9	E-Today kWh	It indicates the power output amount of the current day ,unit;KWh
10	E-Total kWh	It indicates the total power output amount,unit;KWh or MWh

### 5.2 Internal data storage

The device has internal data storage function when use wifi communication, every a certain time, data will be autosaved, when occurring network fault, data can't be uploaded to the server, when network gets well, the stored data will be uploaded to the server again. And the uploaded data will not lose.

#### 1) Historical data storage

Data will be stored every 5 minutes, the data stored including the total power generated, output voltage/current, input voltage/current.

#### 2) Historical data search

Users can search the historical data, and the data will be displayed in graphs, histogram, this can make it convenient for users to master the running state of our inverter every time.

### 5.3 Function of monitor software

Series inverter can realize data reviewing and parameter setting, ect by the monitor software, the following is a brief introduction of the monitor software, and for more details please read the instruction manual of the monitor software.

**Tip** You can download the most updated monitor software and the corresponding user's manual on our website:

#### 5.3.1 Main interface

- 1). Registration interface: for user registration with filling of inverter ID, SN number and other necessary info.
- 2). Sites list: all sites registered by users viewed as a list.
- 3). Sites map: all sites registered by users viewed as a map
- 4). Power curve: daily power curve for tracking
- 5). Power output histogram: daily power output amount in form of histogram for tracking

## 5.4 Inverter working mode

### 5.4.1 Power generating mode

When the external condition satisfies the power generating condition, and after the self-checking gets through, the inverter will enter into the power generating mode.

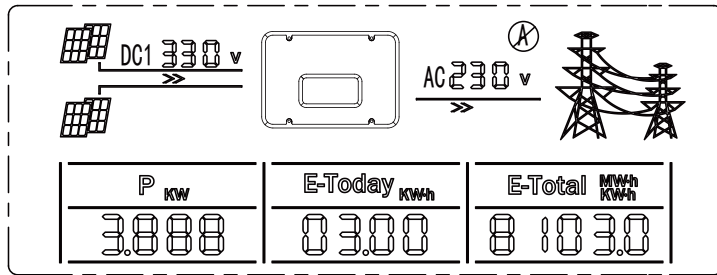

Fig. 5-2

### 5.4.2 Protection mode

If any external fault such as AC side grid fault is detected by the inverter, the inverter will stop power generating and enter the protection mode, in this case the protection indicator on LCD panel will show and display the corresponding protection code. Troubleshooting can be performed by the user according to this code. The inverter will keep monitoring the external fault, and will stay in the protection mode unless the fault is removed. It will be reenter the grid-connect power generating mode one minute later after the fault is removed.

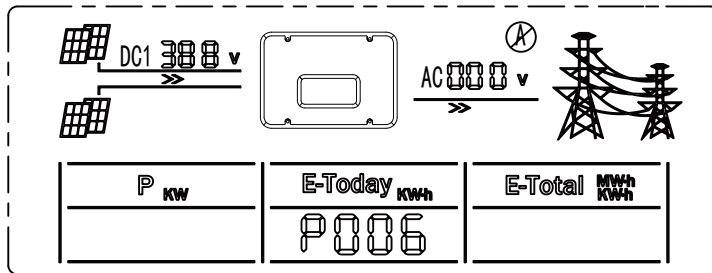

Fig. 5-3

### 5.4.3 Fault mode

If any internal fault is detected by the inverter, the inverter will stop power generating and enter the fault mode, in this case fault indicator on the LCD panel will show and display the corresponding fault code.

Troubleshooting can be performed by the user according to this code. The inverter will keep monitoring if the internal fault is removed. It will reenter the grid-connect power generating mode if the fault is removed.

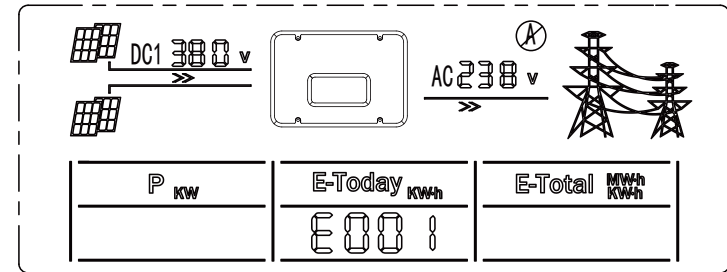

Fig. 5-4



Notice

In the morning and evening, the light intensity is weak and changeful, thus the LCD keep flashing. In order to avoid the user's trouble, and the LCD will light up when it enter into the power generating mode. In other mode, if the user wants to check the relevant data of the inverter, he can tap the inverter body and wake up the LCD.



Notice

When the inverter enter into the protection and fault mode, its corresponding protection and fault code may also appear twice or more. At this time, the protection or fault code display space below the LCD display screen will alternately display a variety of protection or fault code every 2 seconds .

## 5.5 LCD panel power saving mode

The LCD will enter sleep mode if no operation last for 2 minutes , to wake it up please tap on the shell slightly.

## 5.6 LED blink table

Mode \ LED	LCD On			LCD Off		
	LED1	LED2	LED3	LED1	LED2	LED3
Standing-by mode	★					★
Ready mode	★					★
Power Generating mode	●					●
Protect mode	★					★
Fault mode		●			●	

● Lightened constantly

★ Flashing

## 6 Troubleshooting and maintenance

### 6.1 Troubleshooting

This part introduces the common fault and solving steps, provides troubleshooting method and skills to the user, and helps the user identify and solve some common fault of the inverter.



**Tip**

Faults mentioned in this part means the inverter enters the protection state or fault state.

The protection state is mostly caused by some external reasons, the inverter output is not matched with the grid, the grid is power off or the system is not correctly earthed, and thus the inverter acts to ensure the own safety. The inverter itself has no defect and can recover from the protection state if the system is correctly designed and installed.

Sometimes the inverter enters the protection state by the own defect and can be recovered by resetting or repairing.

The fault state is caused by incorrect design of system, e.g: the DC voltage is too high, and thus the inverter acts to protect the system safety. The inverter can be recovered from some faults automatically or by resetting, and some faults are caused by the own defect of the inverter, and in this case the inverter cannot be recovered and shall be repaired.

Correctly identifying the fault state of the inverter is helpful for solving the fault, so please check as per the following steps:

1) Check if the status displayed on the panel is a protection state or fault state, and record all error codes.

2) Try the solution listed in Tab.6-1 and 6-2 and meanwhile check as per the following steps.

- If the voltage at the AC/DC side is normal and if the breaker is switched on?
- If the inverter is installed in a clean , dry and well ventilated place?
- If the cable sectional area satisfies the requirement?
- If the connecting cables is too long?
- If all cables are firmly connected?
- If wiring is reasonable?
- If the safety standard setting is correct?

3) If you meet any problem that you cannot solve by yourself, please contact the client service man for the optimal solution, please provide the detailed system installation information, inverter model, serial number and fault information.

Tab. 6-1: Protection code and solution

Displayed code	Protection description	Recommended solution
P001	The leakage current is too high	1.Cut off the DC breaker and check if there is abnormality in the AC side. 2.After the fault is removed, close the DC breaker and restart the inverter. 3.If the fault occurs repeatedly, please ask for professional service.
P002	The voltage at the grid side is too high	1.Check if the inverter is normally connected to the grid. 2.Check if the grid voltage and frequency are complying with the output scope of the inverter. 3.If the fault above is removed but the inverter can still not work normally, please ask for professional service.
P003	The voltage at the grid side is too low	
P004	The frequency at the grid side is too high	
P005	The frequency at the grid side is too low	
P006	Islanding protection	
P007	The DC voltage is too low	The inverter will recover automatically when the light is sufficient.
P008	Relay open	The inverter will recover cutomatically.
P009	Output current DC offset is too high	1.Check if the inverter is normally connected to the grid. 2.Check if the grid voltage and frequency are complying with the output scope of the inverter. 3.If the fault above is removed but the inverter can still not work normally, please ask for professional service.
P010	Internal synchro communication fail	1.Switch off the DC breaker and wait 1 minute. 2.Switch on the DC breaker and check if the inverter can auto reboot. 3.If the fault occurs repeatedly, please ask for professional service.

Displayed code	Protection description	Recommended solution
P011	Bus voltage low	The inwerter will recover cutomatically.
P012	Bus voltage high	
P013	Inverter current high	
P014	Over temperature	The inwerter will recover cutomatically when the temperatuer gets lower.
P015	Phase lock fail	Phase lock fail,will recover automatically
P016	Transient protect	The inwerter will recover cutomatically.
P017	Inv trip	Inverter self protect,will recover automatically

Tab. 6-2: Fault code and solution

Displayed code	Fault description	Recommended solution
E001	The Insulation Resistance is low	1. Switch off the breaker. 2. Check if the resistance between the +/- poles of the PV assembly and the ground is larger than 1MΩ. 3.If the fault above is remove but the inverter can still not work normally, please ask for professional service.
E002	The DC voltage is too high	1. Switch off the DC breaker. 2. Check if DC voltage is higher than 550V (500V for 2.2k and 450V for 1.5k) . 3. If the fault above is removed but the inverter can still not work normally, please ask for professional service.
E003	The DC input current is too high	1. Switch off the DC breaker. 2.Check if the system is designed incorrectly(DC power too high). 3. If the fault above is removed but the inverter can still not work normally, please ask for professional service.

## 6.2 Daily maintenance

It is unnecessary to maintain the inverter in normal conditions but it is necessary to make sure the inverter is not covered by dust.

### ●Cleaning

The inverter can be cleaned by electric compressed air blower, dry soft cloth or soft brush. Please never clean the inverter by any water, corrosive chemical agent or cleaning agent.

### ●Heat radiation

To protect the normal operation and prolong the service life of the inverter, the inverter must be installed in a well ventilated space without any air barrier surrounding the heat radiator at the back of the inverter, and dust or snow must be removed timely if any.

## 7 Uninstallation

The inverter shall be treated as per the following steps if it is to be replaced or out of service.

### 7.1 Uninstalling steps

- 1) Switch off the AC breaker.
- 2) Switch off the DC breaker.
- 3) Wait for 10min till the inverter is fully discharged.
- 4) Check by a multimeter and make sure neither the AC side nor the DC side is electrified.
- 5) Press the right position of the terminal as Fig.7-1, When you hear a “click”, then you can pull out the positive and negative DC terminal adaptor as Fig.7-2.



Fig.7-1

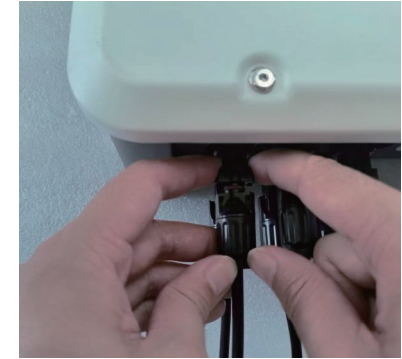

Fig.7-2

### 7.2 Packing

Please pack the inverter with the original package if possible. If the original package is not available, please pack with a carton satisfying the following requirement.

- Firm enough for 45kg.
- Easy for handling.
- Fully closeable.

### 7.3 Storing

The inverter must be stored in a dry and clean place of  $-30^{\circ}\text{C}$  -  $+80^{\circ}\text{C}$ .

### 7.4 Solution at the termination of service period

At the termination of inverter service period, please send the inverter and package material to the designated place for electronic waste treatment. Contact the related authority for treating and recovering if necessary. No inverter or any part can be disposed at random.

## 8 Technical parameters

Tab.8-2:S Serise Plus Parameter

Model No	S1000TL	S2200TL	S3000TL	S3600TL	S4400TL
<b>DC Side / Input Parameters</b>					
Max DC power (W)	1500W	3300W	4500W	5400W	6600W
Max DC voltage (Vdc)	550	550	550	550	550
Min System start/Shut down voltage (Vdc)	65/70	75/100	75/100	75/100	75/100
MPPT voltage range(Vdc)	70~450	100~450	100~450	100~450	100~500
Max. input current (A)			18A		
Max.input short circuit per MPPT			25A		
Number of MPP trackers			1		
Strings per MPP tracker			1		
<b>AC Side / Output Parameters</b>					
Nominal output power (W)	1000	2200	3000	3600	4000
Maximum output power (W) 1	1000	2420	3300	3960	4400
Nominal output voltage/range (V)		208,220,230,240/180~270			
AC grid frequency/range (Hz)	50Hz,60Hz(auto-selection) / 44Hz-55Hz; 54Hz-65Hz				
Maximum output current (A)	6	12	16	18	21
AC connection (with PE)	Single phase				
Current distortion(THDi)	<1.5%	<1.5%	<1.5%	<2.5%	
Power factor	~1%(Adjustable from 0.8 leading to 0.8 lagging)				
<b>Efficiency</b>					
Maximum conversion efficiency	97.3%	97.4%	97.5%	97.8%	97.8%
European efficiency	97.0%	97.1%	97.2%	97.3%	97.3%
MPPT efficiency	99.9%	99.9%	99.9%	99.9%	99.9%
<b>Safety and Protection</b>					
DC reverse-polarity protection			yes		
Anti-islanding / Overvoltage protection			yes		
Short circuit protection			yes		
Leakage current protection			yes		
Grid monitoring / Ground fault monitoring			yes		
DC/AC side SPD(thermally protected)			yes		

Model No	S1000TL	S2200TL	S3000TL	S3600TL	S4400TL
<b>General Parameters</b>					
Dimension (L/W/H)(mm)	315/305/108				
Weight (kg)	5.2				
Embedded DC Switch	Optional				
Night power consumption (W)	< 0.2				
Isolation type	Transformerless				
Protection degree	IP65 according to IEC60529				
Operation temperature (°C)	-25 ~ +60				
Cooling concept	Natural convection				
Operatiing Altitude (m)	<2000m without power derating				
Acoustic noise level (dB)	< 25				
Display	Graphic LCD				
Communication Interface	Standard WIFI; RS485 (optional)				
Warranty	Standard 5 years; 7/10 years optional				
<b>Certificates and Approvals</b>					
CE-(EMC/LVD) : EN(IEC) 61000-1/-2/-3/; EN(IEC) 62109-1/-2					

Tab.8-2:S Serise Plus Parameter

Model No	S5000TL	S6000TL
<b>DC Side / Input Parameters</b>		
Max DC power (W)	7500W	7500W
Max DC voltage (Vdc)	550	550
Min System start/Shut down voltage (Vdc)	75/100	75/100
MPPT voltage range(Vdc)	100~500	100~500
Max. input current (A)		30A
Max.input short circuit per MPPT		40A
Number of MPP trackers		1
Strings per MPP tracker		1
<b>AC Side / Output Parameters</b>		
Nominal output power (W)	5000	6000
Maximum output power (W) 1	5500	6600
Nominal output voltage/range (V)	208,220,230,240/180~270	
AC grid frequency/range (Hz)	50Hz,60Hz(auto-selection) / 44Hz-55Hz; 54Hz-65Hz	
Maximum output current (A)	23	28
AC connection (with PE)	Single phase	
Current distortion(THDi)	<2.5%	
Power factor	~1%(Adjustable from 0.8 leading to 0.8 lagging)	
<b>Efficiency</b>		
Maximum conversion efficiency	97.5%	97.6%
European efficiency	97.2%	97.3%
MPPT efficiency	99.9%	99.9%
<b>Safety and Protection</b>		
DC reverse-polarity protection	yes	
Anti-islanding / Overvoltage protection	yes	
Short circuit protection	yes	
Leakage current protection	yes	
Grid monitoring / Ground fault monitoring	yes	
DC/AC side SPD(thermally protected)	yes	

Model No	S5000TL	S6000TL
<b>General Parameters</b>		
Dimension (L/W/H)(mm)	380*305*118	
Weight (kg)	9	
Embedded DC Switch	Optional	
Night power consumption (W)	< 0.2	
Isolation type	Transformerless	
Protection degree	IP65 according to IEC60529	
Operation temperature (°C)	-25 ~ +60	
Cooling concept	Natural convection	
Operatiing Altitude (m)	<2000m without power derating	
Acoustic noise level (dB)	< 25	
Display	Graphic LCD	
Communication Interface	Standard WIFI; RS485 (optional)	
Warranty	Standard 5 years; 7/10 years optional	
<b>Certificates and Approvals</b>		
CE-(EMC/LVD) : EN(IEC) 61000-1/-2/-3; EN(IEC) 62109-1/-2		

## 9 Quality assurance

### 9.1 Warranty Policy

For our customers we provide 5 years standard warranty from the date of installation, you can also upgrade your standard warranty to 10 years. Please keep the purchasing invoice and trade mark clear for warranty. For more information, please contact your local dealer.

### 9.2 Exception clause

Any of the following situation will not be covered by our warranty policy:

- Use of undersigned purpose.
- Incorrect system design.
- Incorrect installation.
- Use of any unacceptable in the system.
- Misuse or improper operation.
- Any unauthorized modification or repairing.
- The inverter is damaged by any force majeure (electric shock, fire accident, earthquake or seaquake, ect).
- Operating beyond safety regulations.
- Damage during transportation.

### 9.3 Warranty card

Tab. 9-1: Warranty card



### Warranty Card

#### Customer Information

Name:

Address:

Zip Code:

Tel:

E-mail:

Fax:

#### Installation Information

PV module type (parameters):

Number of Strings:

Installation Company:

Modules Per String:

Installation site:

Installer Name:

#### Inverter detailed Information

Fault Time:

Number of used Products:

Date of Bill of Lading:

Fault Messages:

Model of Products:

Number of Fault Products:

Brief Fault Description and Photos (Can be attached):

Customer Signature:

Date:

